

Installation and Operating Instruction Manual

INDOOR COLOR DOME CAMERA



ERD-R248N/R248P
ERD-R255N/R255P

Thank you for your purchase of this product.

Before attempting to connect or operate this product, please read these instructions completely.

Product specifications and its contents subject to change without any prior notice.

The picture is for reference, the object as the standard.

CONTENTS

1. General Information
 - Safety Precaution
 - Package contents

2. Installation of Camera
 - Camera Connection
 - Installation of Camera
 - Tips for Camera Location
 - Dimension

3. Technical Specification

4. Troubleshooting

5. Cleaning and Care

6. Maintenance and Support

1. General Information

► Safety Precaution

1. Read these instructions carefully before commissioning the camera in order to avoid damages caused by improper installation or use.
2. Do not abuse the camera. Avoid striking, shaking, etc. The camera could be damaged by improper handling or storage.
3. Use a dry cloth to clean the camera dome cover when dirty. When the dirt is hard to remove, use a mild detergent and wipe gently. Then wipe off the remaining detergent with a dry cloth.
4. Do not aim the camera at bright objects. Whether the camera is in use or not, never aim it at the sun or other extremely bright objects. Otherwise, blooming or smears may be caused.
5. In case of outdoor use, you have to install the camera in a suitable weather protection case incl. heating element.
6. Operate the camera with the designated voltage only.
7. Use the camera at temperatures within -10 C to +50 C and humidity below 90%.

► Package Contents

1. Indoor Color Dome Camera
2. Operating Instructions
3. Mounting Template Sticker

Caution

To Reduce the risk of electric shock, do not remove cover. No user serviceable parts inside. Refer servicing to qualified service personnel.

2.Installation of Camera

► Camera Connections

12V DC Power Supply

Use standard 12V DC output power supply with 2.1 mm standard DC power female pin. Before connect power check power supply polarity (+ and -).



Video Output Connection

Use standard 75Ω Male BNC pin terminate with Co-axial video cable then connect to camera video out BNC Female pin.

► Installation of Camera

Mounting Template Sticker: The mentioned technical drawing is for reference only. Actual size of Mounting Template Sticker is matched with Dome Base. Stick Mounting Template Sticker supplied for drilling the mounting hole on the mounting surface.

► Tips for Camera Location

1. Never expose the camera to direct sunlight without additional camera housing. Keep sufficient distance to direct heat sources.
2. Never install the camera at humid, oily or dusty locations without using an additional housing. (Without additional housing the camera is not suitable for outdoor use)
3. Do not aim the camera towards indoor lighting, the windows, the sunlight or the sky. (To get good pictures, camera and light should be aimed towards the object)
4. Avoid peak light as background (Also caused by reflection)

► Dimension

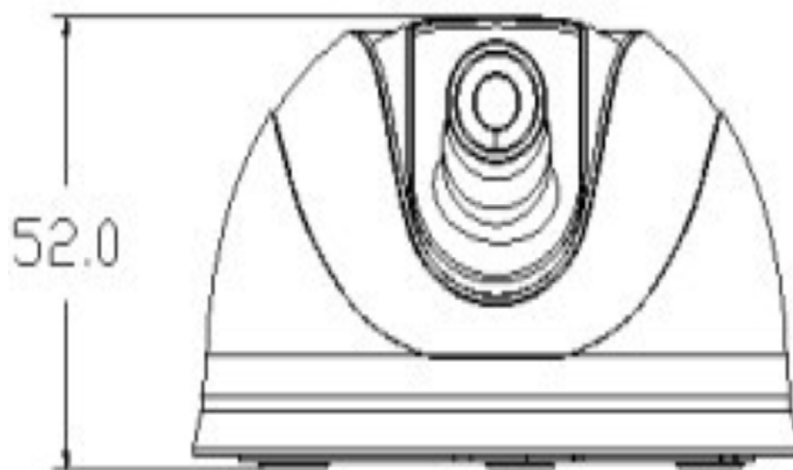
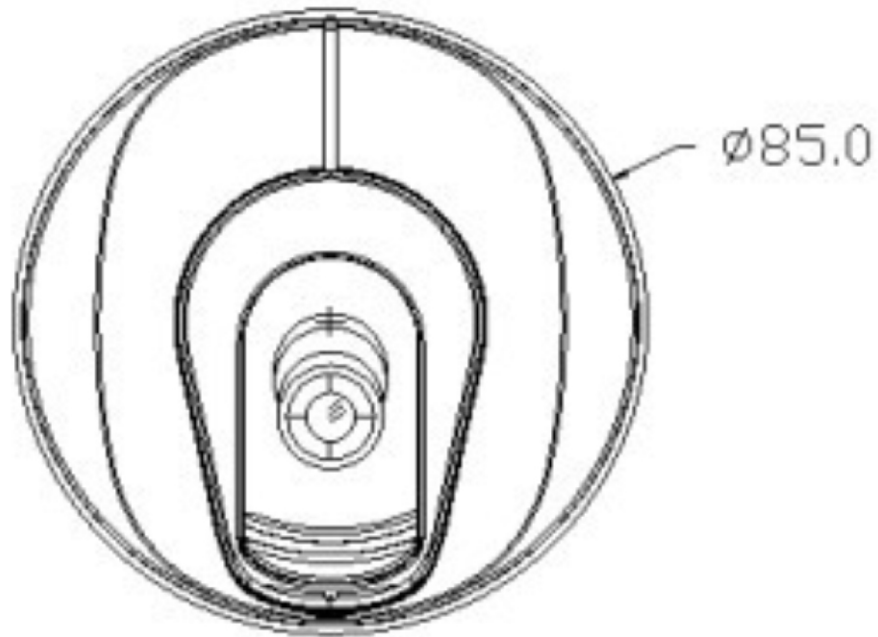

3. Technical Specification

Model Number	ERD-R248N/P	ERD-R255N/P
Video		
CCD	1/3" Sony Super HAD II CCD	
Lens	3.6mm M12 Standard lens	
Effec Pixel@ERD-R247N/P	NTST : 512 x 492, PAL : 500 x 582	
Effec Pixel@ERD-R255N/P	NTST : 768 x 494, PAL : 752 x 582	
Horizontal Resolution	480 TVL	550 TVL
Min. Illumination@Day	0.5 Lux	
Min. Illumination@Night	0.05 Lux	
Scanning Frequency (H)	NTSC : 15.734KHz, PAL : 15.625KHz	
Scanning Frequency (V)	NTSC : 59.94KHz, PAL : 50Hz	
Gamma	0.45	
S/N Ratio	More than 48db	
Video Output	1V p-p, 75Ω	
Sync System	2:1 Internal	
Operational		
IRIS	Electronically	
AGC	Auto	
BLC	Auto	
Day/Night Mode	Auto	
Exposure Mode	AE	
Shutter Speed	NTSC : Auto 1/60s-1/100,000s PAL : Auto 1/50s-1/100,000s	
White Balance	ATW	
Electrical		
Power Supply	12V DC Standard ±10%	
Current Consumption	80mA	
Environmental		
Operating Temperature	-10°C ~ 50°C	
Humidity	95%	
Dimensional		
Housing	2 Axis 2.5" Compact Plastic Dome	
Weight	240g	
Dimension	ø 85 * H 52 mm	

4. Troubleshooting

Error	Cause
No Picture	Check supply voltage, check power cable and video cable
The picture is noisy	Insufficient light (Properly adjusted to the camera)
The picture is too bright	Too much peak light, change camera location or active back light function of the camera
The picture is not sharp	Lens focus not adjusted properly
The picture is distorted	Different GND potentials between camera and monitor (Bad connection)
Ghost Image	Wrong 75 termination, shield of video cable interrupted.

5. Cleaning and Care

- Before you start to clean the camera body, disconnect the unit from power supply.
- For reasons of electrical safety never clean the camera with water or other liquid matters and never put the camera under water.
- To clean use a soft dry cloth. Cleaning the camera inside is strictly forbidden and may only be done by your authorized dealer.
- Since all camera functions are self adjusting and the camera does not contain any parts or components that are subject to wear. We advice you not to open the camera (except for the flap for settings), unless the camera appears to be defective.

7. Maintenance and Support

1. How to request after-sale service?

When ever you want to send repairing material back to us kindly use the same Channel where u purchased the material must with Return Material Authorization (RMA) Form download from our website.

<http://www.eyerisdigital.com/RMA%20Form.pdf>

2. Following cases should be paid even within the warranty period.

A)When defects are caused by the careless handling of the user.

B)When improper or unauthorized repairs are done or when the inside is modified or damaged.

C)Defects caused by natural disaster or power problem.

Technical Support: For any type of product operating, Function, Installation related queries or want to know more about our product details specification or function, contact our website or E-mail to us.

<http://www.eyerisdigital.com/support.html>

www.eyerisdigital.com